

Model One.

**The right choice.**

## Endless possibilities.

Don't even let us get started on the dozens of options you can choose from. You can customize every little detail of the dental unit to completely satisfy your needs.

## Timeless design.

The basis of the design and materials used in the Model One comes from our premium Model Pro line. The design follows proven principles of ergonomics. Enjoy the essential version to comfortably perform your basic daily activities.

## Reliable partner.

Model One is built with similar and simpler mechanics and electronics than our premium line Model Pro. It is made from premium materials.

Its manufacturing technology has been standardized with our premium line and has already been tested and proven reliable long before product release. Each dental unit is thoroughly tested before it is sent to customers.

# The right choice.

Looking for the right dental unit that brings outstanding performance and provides exceptional comfort for your patient at a competitive price? Model One might just be it.



**Model One  
100.**



**Model One  
200.**



# Model One 100.

Carried version



# Model One 200.

Lift version

# Model One 100.

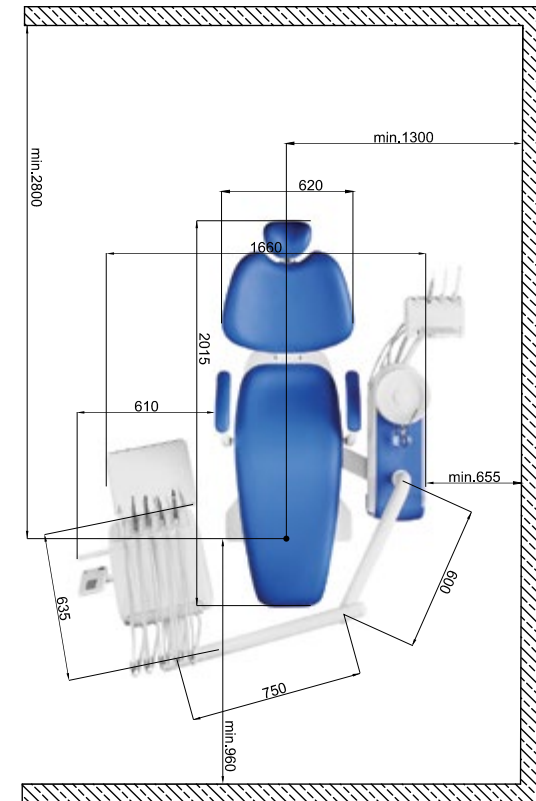
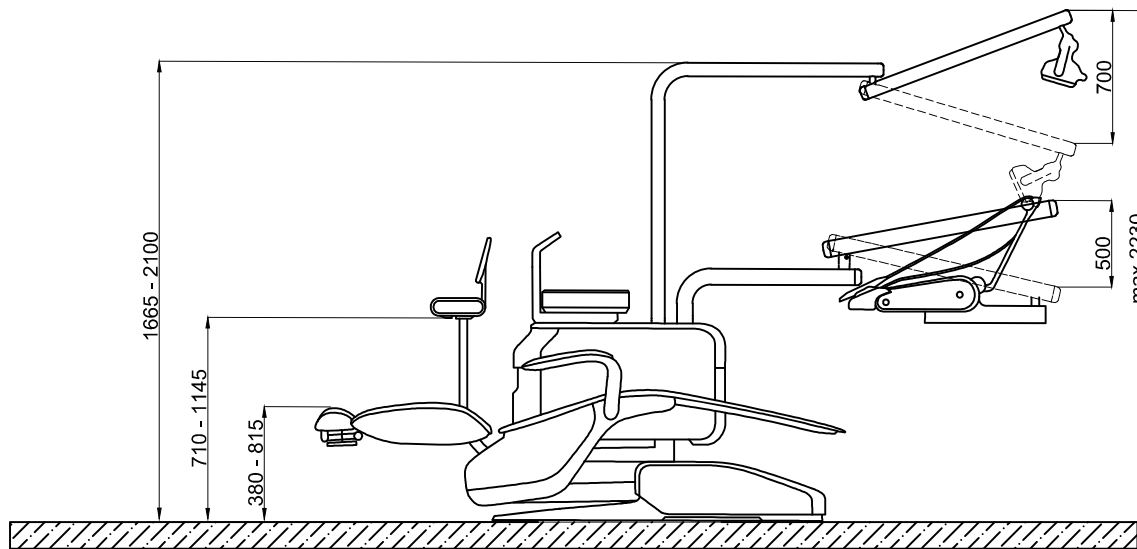

The dental unit with spittoon block and patient chair with synchronized movement. They allow the patient to maintain an optimal distance with the cuspidor bowl during rinsing phases, regardless of the patient's height.

Both models are equipped with a robust chair handling mechanism capable of lifting up to 200kg, making them an excellent choice for practices with a high volume of patients.

# Model One 200.

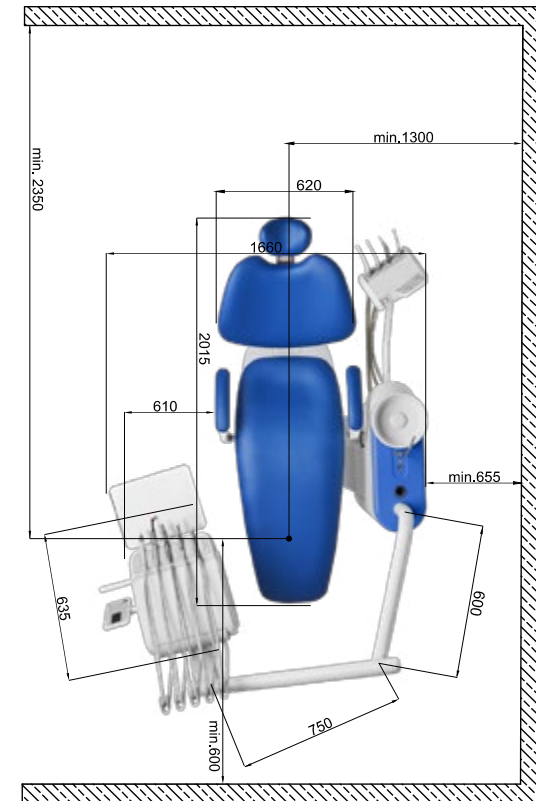
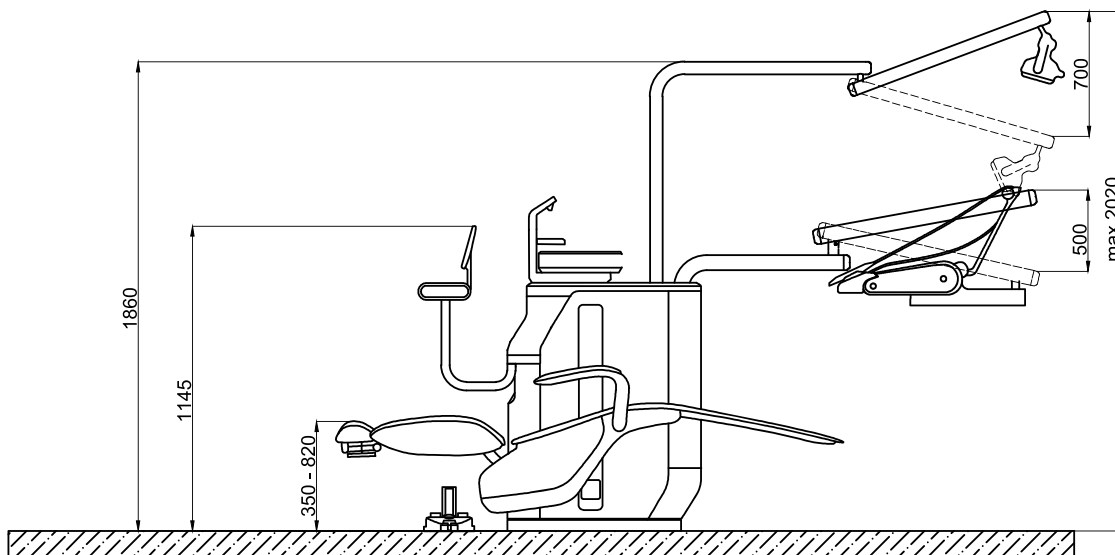

The dental unit with a suspended patient chair and a floor-mounted water unit. It is perfect for practices with limited space due to its compact design. The chair can be lowered significantly to allow easy entry and exit for all patients (the chair can be lowered up to 350 mm from the floor).

Both models are equipped with a robust chair handling mechanism capable of lifting up to 200kg, making them an excellent choice for practices with a high volume of patients.

# Endless possibilities.

Close your eyes and imagine the dream dental unit.  
Now open them, and make it happen with Model One. With  
almost endless customization options, the way your Model  
One looks and works is just up to you.



# Up or down?

Enhance your dentist's element with an upper or lower hose delivery system.

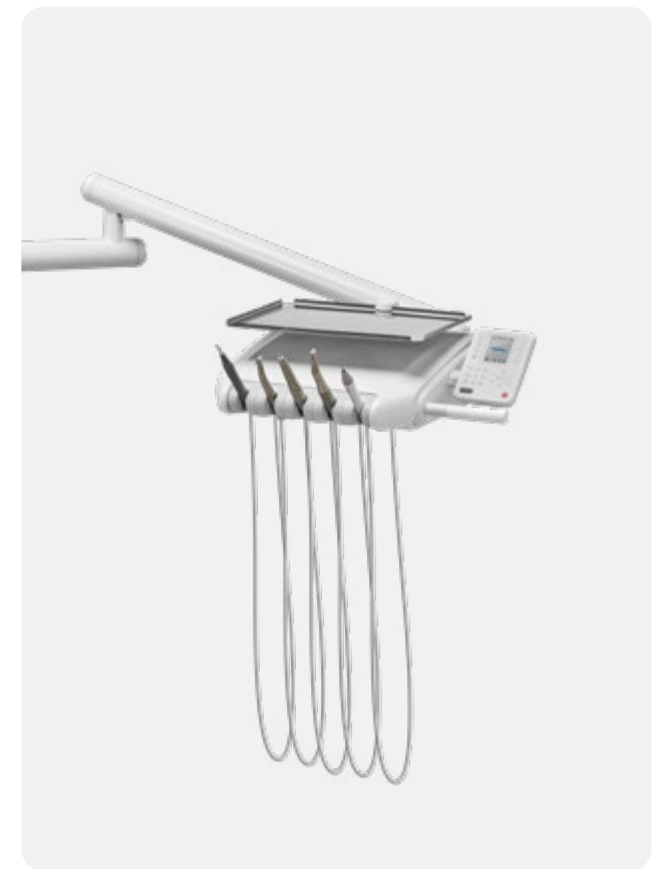
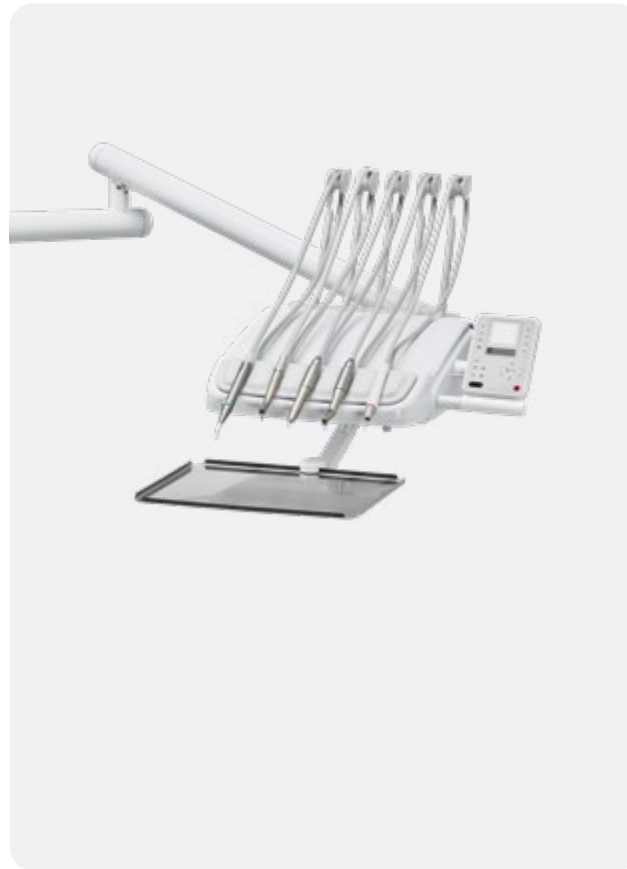

## Hold the whip hand.

The dentist's element with instrument hoses routed in the upper hoses configuration may be equipped with a whip lock. An instrument whip is routed to the instrument placed in a designated slot. The whip is pulled towards the stop to unlock. The whip then returns to its resting position.



## Put your skills on display.

The control panel on the dentist's element comes in two variants. The button layout of both options include controls for four custom chair positions and the getting-on position. You can also pre-program two unique dentist profiles for both of the variants.



### Control panel One.

The standard control panel comes with a 5-digit display unit which provides you with information regarding the RPM of the currently used micromotor. This version of the control panel includes buttons for the chair, light, cup and cuspidor control. It also rocks a fancy negatoscope!



### Control panel One Plus.

The advanced control panel comes with a full-color display and extra buttons to control the endodontics functions of your instruments. This choice also supports automatic hygiene.

**1** Buttons for light,cup, cuspidor

**2** Buttons for chair control

**3** Buttons for instrument settings\*

## Intuitive instrument control.

The instruments on the dentist's element are activated once removed from the individual holsters.

## One button to rule them all.

The instrument settings can be customized with four different presets.



## Multi-colored LED indicators on Control panel One.

To support a dentist's workflow while using Control Panel One we use intuitive multi-colored LED indicators to recognize switching functionalities.

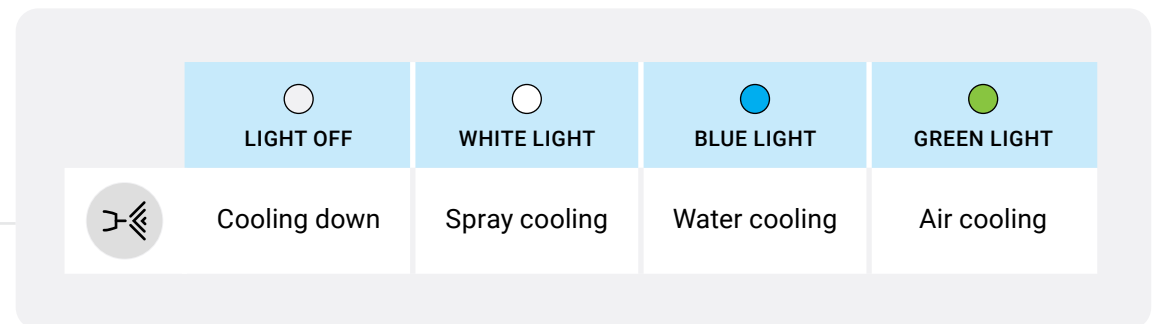

# Pick your scaler.

The selection of scalers compatible with Model One's Control panel One Plus includes:



Scaler	PERIO	ENDO	SCALING & GENERAL	BOOST
Satelec SP Xinetic	•	•	•	
Satelec NEWTRON	•	•	•	•
Satelec NEWTRON LED	•	•	•	•
NSK VA170	•	•	•	
NSK VA170 LED	•	•	•	
WOODPECKER		•	•	

EMS The EMS scalers do not have specific functions. Their intensity range is from 0-10, which covers all modes.



# Endodontic functions.

Control Panel One Plus with micromotor DX Pro or DX Pro Blue enables you to use additional endodontic functions. This includes auto-reverse and auto-forward features.

It's possible to adjust the speed range from 100 to 40,000 RPM and the torque is adjustable to 3.5Ncm.

## And yet it moves!

The standard version of the Model One's cuspidor is fixed to the cuspidor. However if you want to provide your patients with additional comfort, you can choose the rotary option.



## What light will you turn on?

You can choose from the XENOS or the MAIA dental lamps. The Xenos lamp reaches up to 26.000 Lux. The MAIA lamp up to 35.000 Lux and CRI>95. Both lamps have hands-free operation functions thanks to the no-touch sensor.



## Pedal to the metal.

Even though you might not feel the same adrenaline as in a racing car, you get ergonomic and practical benefits from using foot controllers. You can select from three options compatible with Model One.



### MARQUARDT

Stable and skid-proof thermoplastic housing with rubber feet.



### NOK

Vertically operated multifunction foot pedal to control instruments, chair and water unit.



### SWING

Horizontally operated multifunction foot pedal for controlling instruments, chair, and water unit. With Improved ergonomics and easy control of the instruments' spray with the lever.

## Ready for an extra pair of hands.

The assistant's element has six instrument holders. Two versions are available: BASIC and ADVANCED. The BASIC assistant element allows the assistant to control cuspidor rinsing and cup refilling. With the ADVANCED assistant's element, you will also be able to control the chair's movements, including the Trendelenburg position.

Basic

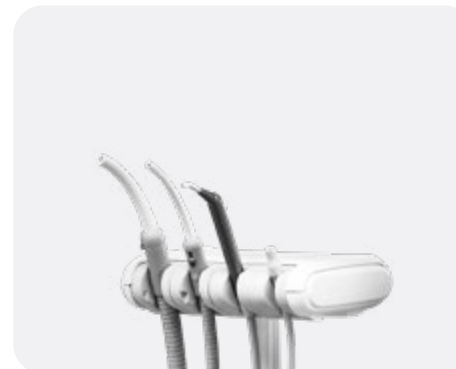

Advanced





## **Fast, faster, Model One.**

Model One has simple manual hygiene in the standard version, but you can upgrade to fully automatic hygiene. Model One maintenance is fast and easy, regardless of your choice.

## **Even manual disinfection is an easy chore.**

If you choose the standard version of Model One, which is not equipped with an automatic water channel and suction hose hygiene system, regular manual hygiene is still possible. All of the systems are very easily maintained and come with simple and clear recommendations.

## **Automatic disinfection of instrument water channels.**

The recommended disinfectants are Alpron, Sanosil S003, or Dentosept P in a 1% concentration with distilled water. These products in a 1% concentration are completely inert with respect to patients.





**Hygiene holder.**



**Instrument hoses in hygiene holder.**



**Automatic hygiene of big and small suction hoses.**

## **Intensive disinfection of instrument water channels.**

The recommended disinfectants are Alpron, Sanosil S003, or Dentosept P in a 100% concentration. The cooling system channels are kept clean and there is no need to use other means of disinfection.

---

## **Automatic hygiene has 4 settings options:**

- |  |                                       |
|--|---------------------------------------|
| <b>1.</b><br>Beginning of a workday hygiene. | <b>2.</b><br>After treatment hygiene. |
| <b>3.</b><br>End of a workday hygiene.       | <b>4.</b><br>Intensive hygiene.       |

# Timeless design.

We shaped the award-winning design of our Model Pro Series and used it to create the Model One fundamental design, to support the dentist in their essential needs. The same materials, body parts, and ergonomically oriented design philosophy.

## Business class tickets, please.

Next time your patients visit you, let them know they may as well imagine they're sitting in a limo. Why? We've teamed up with ergonomics experts from the dental industry to design this absolute masterpiece of a dental chair to reduce your patient's physical strain and make them as comfy as possible.



## Simple is an understatement.

The control panels use a clear and simple button layout, graphics, and a high-quality surface finish. We've kept it simple, so you can completely focus on your job without any distractions or mistakes.





## Hard to get your eyes off of it.

Clean geometry, well-designed user interface, compact size, and great ergonomics. All of these combine to make Model One not just a sight to see, but, also a great product to use.



## Pleasant to the touch.

Most of the materials used, such as UV-resistant and chemically resistant ASA plastic or galvanized semi-matte metals, can match even the most premium products on the market.

# Love at first seat.

The base of Model One's design, ergonomics and materials used come from our premium model line Model Pro.

- a) The backrest is wide enough to ensure patients' upper body side movement.
- b) For the most demanding dentist, a 3D headrest is essential to allow a lateral flexion position of the patient head.

**Headrest accepts** and copies the shape of the neck and head of any patient.

**Shoulders naturally drop** so as to ensure a comfortable back position.

**Seat and backrest** relieve the patient and make them feel supported.

**The Trendelenburg position is a standard feature.**

**Lying position** with legs fully supported and arms resting comfortably to enhance relaxation.

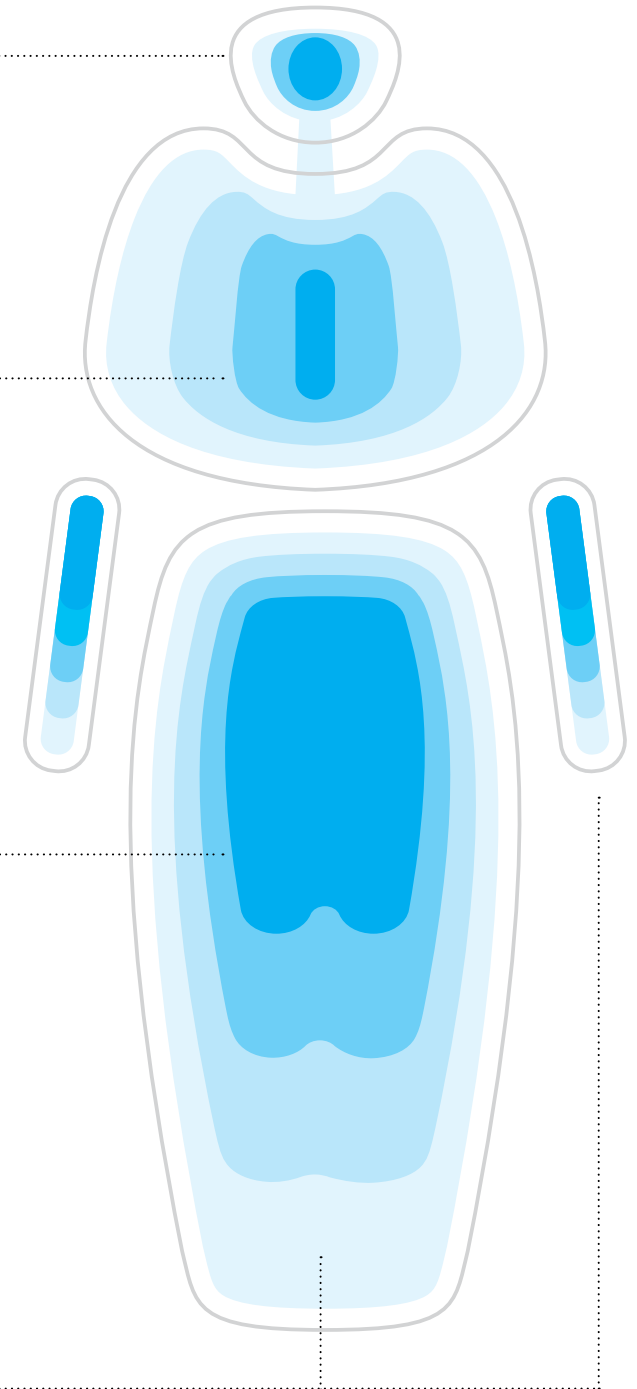

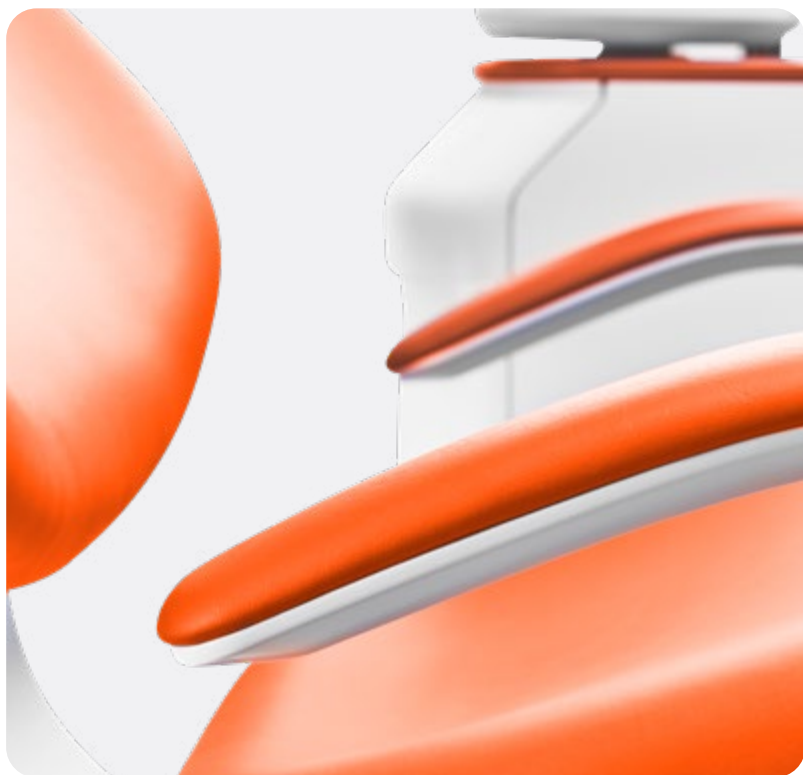

## Model One takes care of you.

It's not just your patients but you that deserve the best. Musculoskeletal problems appear to be the leading cause of dental practitioners' premature retirement from practice.

Great ergonomics are essential for your long-term health. Model One meets all the conditions for ergonomic work, from palatine treatment to operational positions.

## Some of the ergonomic highlights:

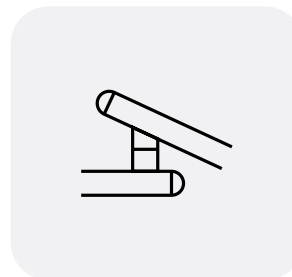

The dental unit's arms are ergonomically adapted for your daily work.



The backrest allows the sideways movement of the patient's upper body.

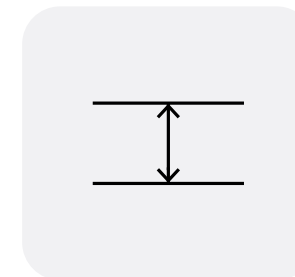

Minimum backrest thickness to allow dentists to get close to the patient's head.

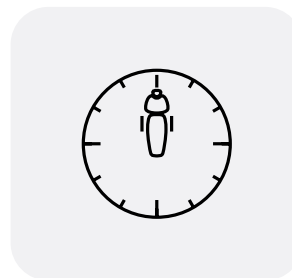

The dentist's and assistant's elements can get incredibly close for a two-handed treatment at the 12 o'clock position.

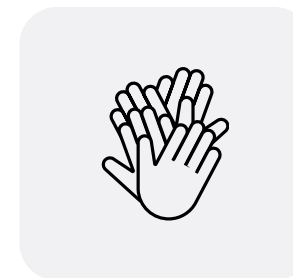

The assistant's element can free the space for four-handed treatment.

# Feeling frisky?

Whatever you feel like, we're giving you the freedom to express yourself. With the choice of dozens of color and upholstery options, it's just about your preference. Take a look at the most popular choices. You'll find all available options in our [upholstery catalogue](#).

## Standard Collection.

By picking the Standard version, you will be able to enjoy the typical leather look. This soft-to-touch and flexible material is highly durable, resistant to scratches, and well-protected from UV radiation.



## Special Collection.

By picking the Special version, you will be able to enjoy the typical leather look. This soft-to-touch and flexible material is highly durable, resistant to scratches, and well-protected from UV radiation. Not only that, you will have unique colors to choose from!



## Special Plus Collection.

Light material with high flexibility and a perfect finish. By being phthalate-free, the Swiss-made Special Plus version brings extra safety for the user while being easily cleanable and meeting all fire safety standards.



## Premium Collection.

With its natural grainy look, the Ultra-leather Premium version delivers a quintessentially classic style that elevates the experience of leather. It is soft to the touch with reinforced rayon backing and industry-leading cutting-edge durability. Premium stitched upholstery is available to order only with active foam to ensure maximum patient comfort.





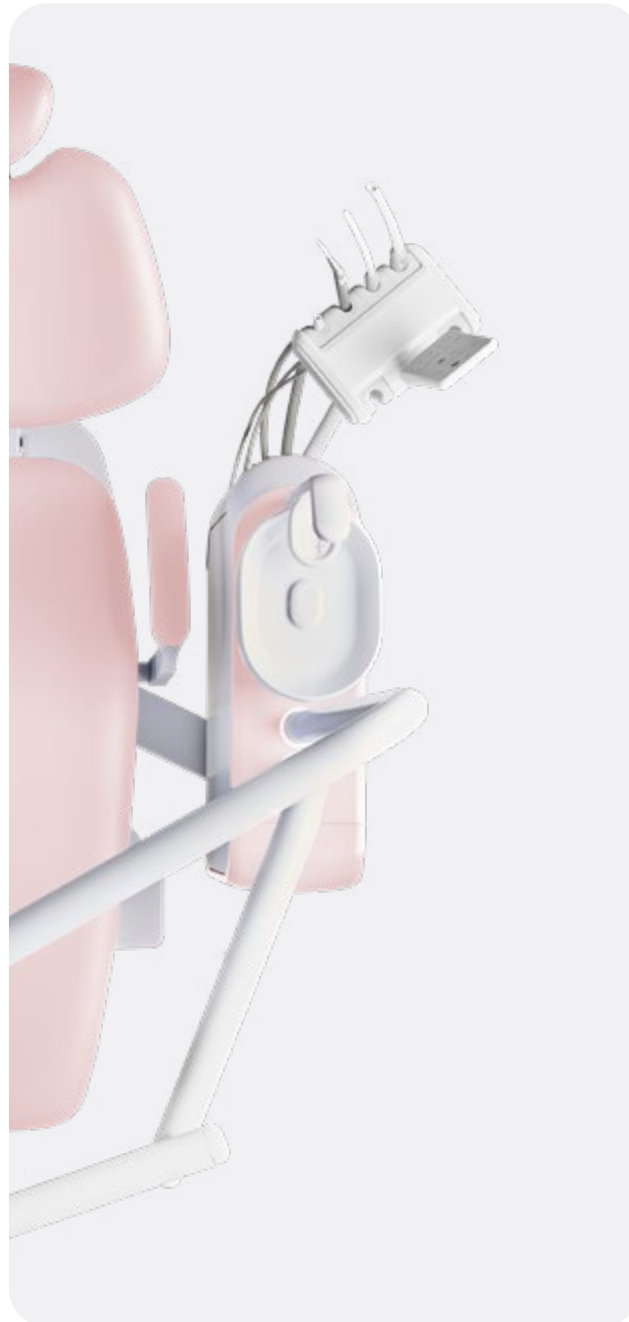

**Choose  
custom color  
for upholstery  
and plastic  
cover.**



# Express your style.



Choose from new color options and match your upholstery with other parts of the dental unit.

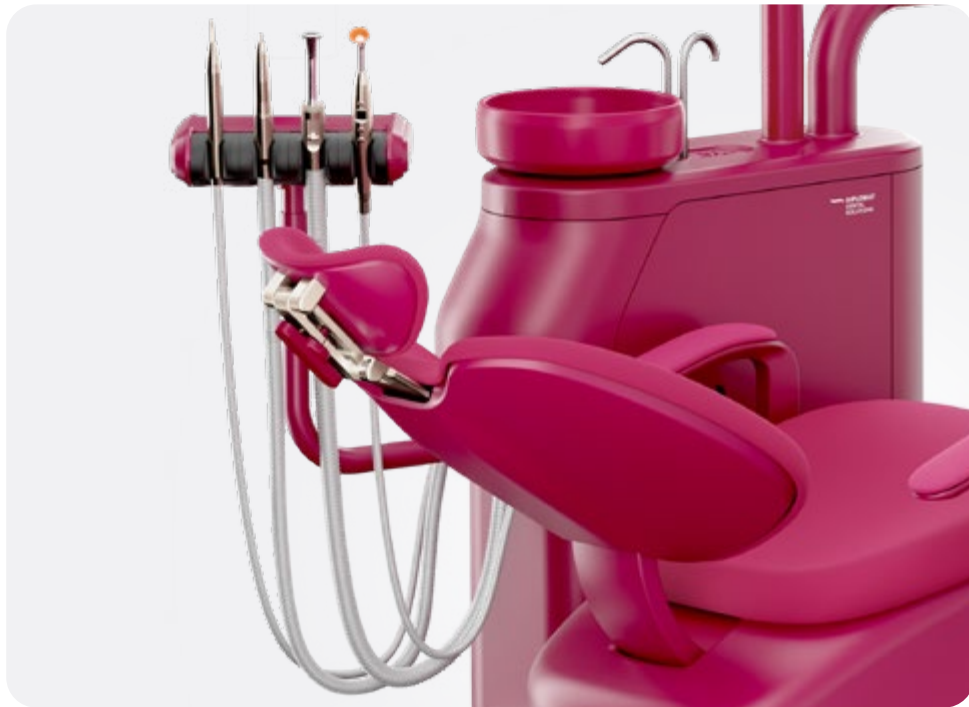

The full painted units photos presented are demonstrative. Some of the elements of the unit, such as foils (control panel, assistant element), instrument holders, whip arms, rubber covers, must remain in original colors, cannot be painted. Ask your dealer for details.

# Reliable partner.

Ease of use and essential functions are the main philosophy behind Model One. Even on your first day with Model One, it will feel like you've worked with it for ages.

## In your natural habitat.

Model One provides comfortable access to all your tools, instruments and control panels at all times.

## Comfortable for all shapes and sizes.

The range of the chair lift is extremely large – from 35 cm to 82 cm. Thanks to this, your child patients will easily be able to hop onto the chair. It also provides a comfortable workspace for dentists of smaller or even larger stature.

## Installation? Eaaaasyyyyyy.

The installation of Model One is very easy and swift, and you can start working almost as soon as it's delivered to you.



# Get to know Diplomat Dental.



Diplomat Dental is a family company with a tradition dating back to 1945. Located in the European dental valley, in Piešťany, approximately 100 kilometers away from Vienna, it holds the perfect position not only in terms of location but also experience gained over the 60 years of development. With thousands of satisfied dentists all over the world, the company is now making the breakthrough into digitized dentistry with the help of the 3rd generation of Nerád family CEO.



**1945**

Miroslav Nerád becomes the CEO of Chirana, the predecessor of Diplomat Dental.

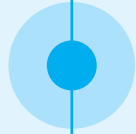

**1950**

The first dental accessories are being developed.

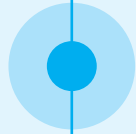

**1989**

Chirana is divided into multiple independent companies.

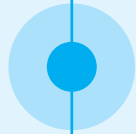

**1992**

Eur-Med distribution company is founded by Miroslav Nerád II.

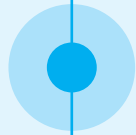

**1996**

Nerád family invests into the Piešťany headquarters.

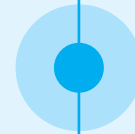

**2012**

Chirana rebrands to Diplomat Dental.

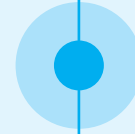

**2013**

Tomáš Nerád becomes CEO of Diplomat Dental.

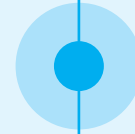

**2021**

A new premium product line Model Pro is introduced. It won multiple design awards including the most prestigious one – Red Dot Design Award.

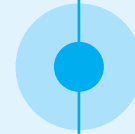

**2022**

Model One is introduced to the market.



**2023**

Tomáš Nerád wins the EY Technical Entrepreneur of the year award.



# Focus on reliability & high quality.

All our products are carefully designed and engineered to meet the specific needs of our customers while always attaining our high-quality standards.

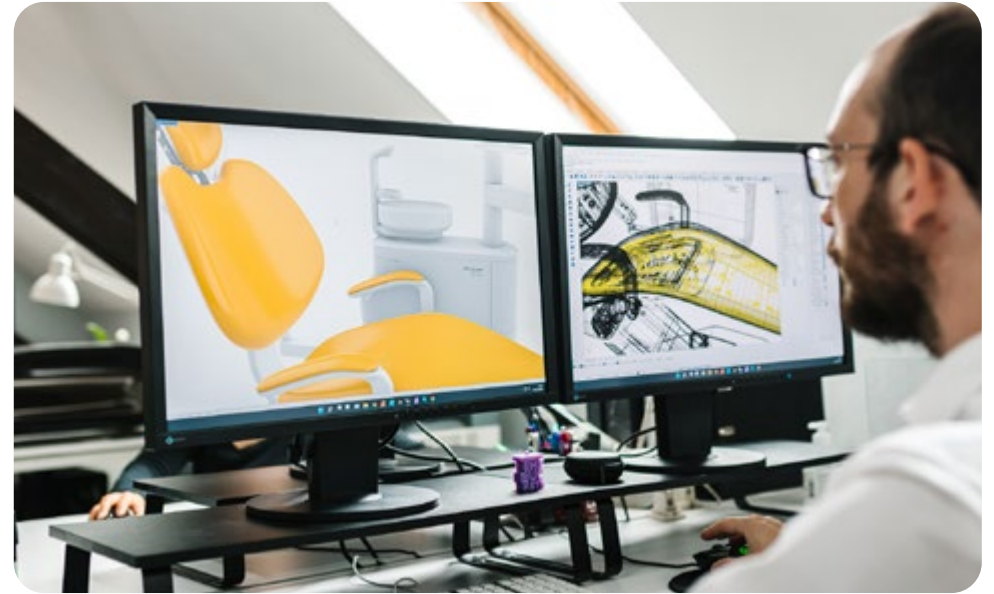

90% of our components are manufactured in-house. Each component of every dental unit is thoroughly checked more than 15 times during the manufacturing process as we process it from the input material to the final element of the dental unit.

One of our biggest strengths lies in our R&D team and our numerous cooperations with experienced partners and industry experts.

Each newly developed product is tested internally for four months





to a year in our internal test room. After this process, our beta tester dentists work with the prototypes for up to one year while we use their feedback to fine-tune the product.



Diplomat Dental products are highly customizable. We can accommodate specific requirements and needs of our customers.



"Our product philosophy is to focus on open platforms, modular and intelligent solutions that improve the workflow of your dental office – making advanced technologies and smart tools easy to use and accessible to every dentist."

**Tomas Nerad,**  
CEO – Diplomat Dental

# Get the full experience with our accessories.

Take a look at our full range of accessories that are compatible with Model One.

## Dentist element



Standard  
**Traditional style**  
5 instrument option



Standard  
**Continental style,**  
5 instrument option

## Control pannel



Standard  
**One**



Optional  
**One Plus**

## Assistant's element



Standard  
**Saliva ejector with**  
adapter on water unit



Optional  
**Basic**



Optional  
**Advanced**

## Cuspidor



Standard  
**Fixed cuspidor**



Optional  
**Rotating cuspidor (manual rotation only)**

## Headrest



Standard  
**2D**



Optional  
**3D**

## Lamp



Standard  
**XENOS**



Optional  
**MAIA**

## Footcontroller

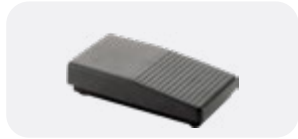

Standard  
**Marquardt**



Optional  
**Nok**



Optional  
**Swing**

## Tray



Optional  
**Extra tray table**  
sized 370x290 mm on the light pole

## Monitor



Optional  
**Nevo monitor 22" DR22 white Widescreen**  
**Nevo monitor 22" RX22G black, FULL HD Widescreen**

## Upholstery types



Standard (seamless)  
**Upholstery**



Stitched  
Upholstery

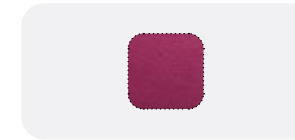

Stitched (Premium)  
Upholstery with Active foam

## Water unit



Standard  
**Big and Small suction hoses with manual regulation (one filter)**



Optional  
**Big and Small suction hoses with selection valve (two filters)**

## Stool



Optional  
**With a backrest for the dentist, With a backrest for the assistant, Horse-seat for a microscope**

## Accessories



Optional  
**Pillow for children**



Optional  
**Protection cushions**

## Paint

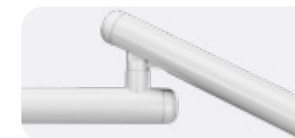

Optional  
**Complete paint in semi-matt white**

# Choose your own features.

Configure Model One to become your dream dental unit.

Model One 100		Model One 200	
Plate for non-grounding/floating floor/exhibition	<input type="radio"/>	Plate for non-grounding/floating floor/exhibition	<input type="radio"/>
Synchronized movement of backrest and patient chair	<input type="radio"/>	Synchronized movement of backrest and patient chair	<input type="radio"/>
Headrest 2D	<input type="radio"/>	Headrest 2D	<input type="radio"/>
Headrest 3D	<input type="radio"/>	Headrest 3D	<input type="radio"/>
Left armrest	<input type="radio"/>	Left armrest	<input type="radio"/>
Right armrest	<input type="radio"/>	Right armrest	<input type="radio"/>
Pillow for children	<input type="radio"/>	Pillow for children	<input type="radio"/>
Protection cushion	<input type="radio"/>	Protection cushion	<input type="radio"/>
<b>Dentist's element</b>			
Continental style with 5 instruments			<input type="radio"/>
Traditional style with 5 instruments			<input type="radio"/>
<b>Control Panel</b>			
Control Panel "One" with negatoscope			<input type="radio"/>
Control Panel "One Plus" <i>*compulsory to run the Endo function and automatic sanitization process</i>			<input type="radio"/>
<b>Dental lights</b>		<b>Cuspidor</b>	
Xenos (up to 26.000 Lux)	<input type="radio"/>	Fixed cuspidor	<input type="radio"/>
Faro MAIA LED lamp with sensor (35.000 Lux)	<input type="radio"/>	Rotating cuspidor (manual rotation only)	<input type="radio"/>
<b>Light pole</b>		<b>Dentist's element additional options</b>	
Light pole for operating light only	<input type="radio"/>	Separate water regulators for each instrument	<input type="radio"/>
Light pole for operating light and suitable for extra tray	<input type="radio"/>	Whip lock only for CS (upper hose) delivery system	<input type="radio"/>
Light pole with operating light, suitable for tray plus monitor adapter	<input type="radio"/>		
<b>Tray and Monitor</b>			
Extra tray table	<input type="radio"/>		
Neovo monitor 22" DR22 white	<input type="radio"/>		
Monitor Neovo 22" RX22G black	<input type="radio"/>		

Assistant element	
BASIC assistant's element	<input type="radio"/>
ADVANCED assistant's element	<input type="radio"/>
Saliva ejector with adapter on water unit	<input type="radio"/>

Assistant element arm	
Short arm (ideal for 4-hands treatments)	<input type="radio"/>
Long arm (ideal for 2-hands treatments)	<input type="radio"/>

Stools			
D10L with back-rest for the dentist	<input type="radio"/>	D10L horse-seat	<input type="radio"/>
D10L with back-rest for sister	<input type="radio"/>	D10L for microscope	<input type="radio"/>

Warranty			
Standard two-year warranty period	<input checked="" type="radio"/>	Extra two-year warranty	<input type="radio"/>
Extra one-year warranty period	<input type="radio"/>	Extra three-year warranty	<input type="radio"/>

Foot Control	
SWING foot control (recommended by Diplomat Dental)	<input type="radio"/>
NOK foot control	<input type="radio"/>
Marquart foot control	<input type="radio"/>

Upholstery	
Standard (seamless) upholstery	<input type="radio"/>
Stitched upholstery	<input type="radio"/>
Premium Stitched upholstery with ACTIVE FOAM	<input type="radio"/>

The colors of the leather can be selected in the upholstery catalogue.

Assistant's element instruments	
Minimate 3F syringe	<input type="radio"/>
Minilight 3F syringe	<input type="radio"/>
Mectron Starlight	<input type="radio"/>
Monitex curing light	<input type="radio"/>
Rollers for big and small suction hoses (2pcs.)	<input type="radio"/>
Diplomat intraoral USB camera with software for connection with PC and accessories	<input type="radio"/>
Additional saliva ejector (not possible to combine with "only saliva ejector" option and with any amalgam separator)	<input type="radio"/>

Color version of dental units	
Color set painting on water unit – possible to choose from all colors.	<input type="radio"/>
Complete unit painted in semi matt.	<input type="radio"/>

Instruments for dentist's elements	
<b>SYRINGE</b>	
Minimate 3F syringe	<input type="radio"/>
Minilight 3F syringe	<input type="radio"/>
Minilight 6F syringe	<input type="radio"/>
Minilight 6F syringe straight with light and module	<input type="radio"/>
<b>MICROMOTOR</b>	
SET DENSIM DX motor with accessories	<input type="radio"/>
SET DENSIM DX PRO motor with accessories	<input type="radio"/>
SET DENSIM DX BLUE motor with accessories	<input type="radio"/>
SET DENSIM DX PRO BLUE motor with accessories, endo functions auto reverse, auto forward	<input type="radio"/>
<b>SCALER</b>	
Module and accessories for scaler <i>*to be selected, to add a scaler on the dentist element</i>	<input type="radio"/>
LM-ProPower UltraLED scaler with light with module (4 tips)	<input type="radio"/>
EMS MiniPiezon FS-433 scaler without light (3 tips)	<input type="radio"/>
EMS MiniPiezon FS-432 LED scaler with light (3 tips)	<input type="radio"/>
EMS MiniPiezon FS-367 LED scaler with light (3 tips)	<input type="radio"/>
Satelec SP Xinetec scaler without light (1 tip)	<input type="radio"/>
Satelec NEWTRON scaler without light (3 tips)	<input type="radio"/>
Satelec NEWTRON LED scaler with light (3 tips)	<input type="radio"/>
NSK VA170 scaler without light with module (3 tips)	<input type="radio"/>
NSK VA170 LED -Lux scaler with light with module (3 tips)	<input type="radio"/>
Woodpecker UDS-N3 LED scaler (6 tips)	<input type="radio"/>
<b>CURING LIGHT</b>	
Mectron Starlight	<input type="radio"/>
Monitex curing light	<input type="radio"/>

Disinfection systems	
Semi-automatic disinfection of instruments with Alpron (0,6l additional bottle, 1L Alpron, instruments adapter to be fitted into spittoon bowl)	<input type="radio"/>
Automatic and continuous disinfection of cup filler and instruments hoses (includes extra bottle for disinfection agent)	<input type="radio"/>
Integrated WEK disinfection system in compliance with EN1717	<input type="radio"/>
Automatic decontamination for suction hoses	<input type="radio"/>

Dry suction system	
Venturi system, ejector accessories (Dürr control of suction aspirators - manual changeover of aspirators + Dürr filter)	<input type="radio"/>
Cattani miniseparator	<input type="radio"/>
Dürr CS1 separator	<input type="radio"/>
METASYS ECO-L1, separator water-air	<input type="radio"/>
MST1 amalgam separator (including sample disinfection set + applicator + replacement container) separation rate 98,6%	<input type="radio"/>
Dürr CAS-1 amalgam separator, (including replacement container) separation rate 97,9%	<input type="radio"/>

Options for central water supply	
Central water supply (including 2.5 bar water regulation) + depressurization bottle system	<input type="radio"/>
Funnel for comfort bottle access for central water supply	<input type="radio"/>

Suction hose regulation	
Only BIG (HVE) Suction with manual regulation	<input type="radio"/>
Only Saliva Ejector	<input type="radio"/>
BIG (HVE) and SMALL Suction with manual regulation - one wet suction filter	<input type="radio"/>
BIG (HVE) and SMALL Suction with Automatic suction control & Multi-station Valve (two suction filters)	<input type="radio"/>

Wet suction system	
Standard wet suction	<input type="radio"/>
Extra charge for selection valve (for dental offices with two or more dental chairs)	<input type="radio"/>
Extra charge for selection valve & Duerr Cuspidor valve for wet suction (drain and suction air go to suction machine)	<input type="radio"/>

Options without central water supply	
2.5 bar water regulation (needed when water inlet pressure is too high)	<input type="radio"/>
Depressurization bottle system	<input type="radio"/>
Funnel for comfort bottle access for unit without central water supply	<input type="radio"/>

Water unit options	
Distilled water bottle	<input checked="" type="radio"/>
Front panel for external media connections ( air, water, power ) including 2.5 bar water regulation	<input type="radio"/>

# Enter the era



# of smart dentistry.



# Discover the Diplomat Dental portfolio.

Check out our Model Pro Series to find out more about the new era of digitized dentistry.



Model Pro 500.



Model Pro 600.



Model Pro 700.



Model Pro 800.

## Discover the Diplomat Dental portfolio.



Chair Pro.



Dental stools.







Densim microscope.



**Contact our sales team:**

+421 33 7954 111  
info@diplomat-dental.com

**Follow us:**

-  @diplomat\_dental
-  Diplomat dental
-  Diplomat Dental Solutions
-  Diplomat Dental Solutions

**Showroom address:**

DIPLOMAT DENTAL s.r.o.  
Vrbovská cesta 17  
921 01 Piešťany  
Slovak Republic

**www.diplomat-dental.com**

